

AV5000

WHY RAMEX HOSE REELS › PERCHÈ UN AVVOLGITUBO RAMEX

■ SAVE TIME	■ RISPARMIO DI TEMPO
■ SAVE MONEY	■ RISPARMIO DI DENARO
■ INCREASED SAFETY	■ SICUREZZA SUL LAVORO
■ LONG HOSE DURABILITY	■ INCREMENTA LA DURATA DEL TUBO
■ EFFICIENCY IN DAILY WORK	■ EFFICIENZA NEL LAVORO QUOTIDIANO
■ 100% MADE IN ITALY	■ MADE IN ITALY 100%

WHERE TO USE › DOVE UTILIZZARLO



PROPER USE › CORRETTO UTILIZZO

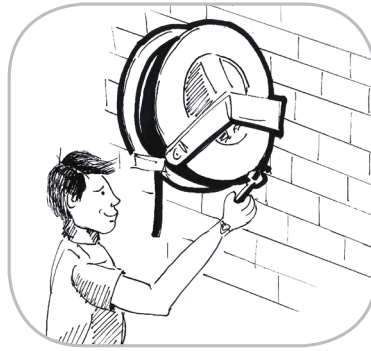

1



2



3



4



5



6

RAMEX

video



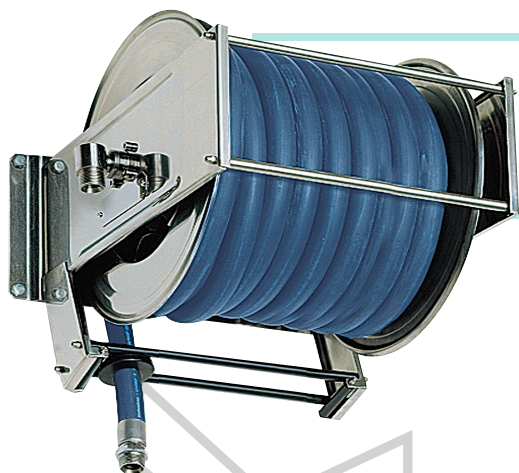

AV5000

TECHNICAL FEATURES › CARATTERISTICHE TECNICHE

AV5000 AISI 304

Admitted diameters Diametri ammessi	3/4" - 1"
Hose lenght in meters Lunghezza tubo	Up to 98.4 ft 3/4" - Up to 82.0 ft 1" Fino a 30 mt 3/4" - Fino a 25 mt 1"
Working pressure Pressione lavoro	Up to 1500 psi / Fino a 100 bar
Working Temperature Temperatura lavoro	212°F - 100°C *
Inlet thread size Connessione Ingresso	1" M
Outlet thread size Connessione uscita	3/4" F
Weight Peso	40 kg
Packing size Dimensione imballo	550x570x630 mm
Raw material sides and roll Materiali costruttivi rullo e fiancate	AISI 304
Raw material shaft and swivel joint Materiali costruttivi perno e giunto	AISI 303
Raw material main spring Materiale molla principale	Carbon Steel Acciaio al carbonio
Can be used to transfer Adatto all'utilizzo con	Air Water Chemical Aria Acqua Prodotti Chimici
Included Accessories Accessori inclusi	Hose bumper (3/4" o 1") Tampone finecorsa (3/4" o 1")

AV5000 AISI 316

Admitted diameters Diametri ammessi	3/4" - 1"
Hose lenght in meters Lunghezza tubo	Up to 98.4 ft 3/4" - Up to 82.0 ft 1" Fino a 30 mt 3/4" - Fino a 25 mt 1"
Working pressure Pressione lavoro	Up to 1500 psi / Fino a 100 bar
Working Temperature Temperatura lavoro	212°F - 100°C *
Inlet thread size Connessione Ingresso	1" M
Outlet thread size Connessione uscita	3/4" F
Weight Peso	40 kg
Packing size Dimensione imballo	550x570x630 mm
Raw material sides and roll Materiali costruttivi rullo e fiancate	AISI 316
Raw material shaft and swivel joint Materiali costruttivi perno e giunto	AISI 316
Raw material main spring Materiale molla principale	Carbon Steel Acciaio al carbonio
Can be used to transfer Adatto all'utilizzo con	Air Water Chemical Aria Acqua Prodotti Chimici
Included Accessories Accessori inclusi	Hose bumper (3/4" o 1") Tampone finecorsa (3/4" o 1")

AV5000 FE

Admitted diameters Diametri ammessi	3/4" - 1"
Hose lenght in meters Lunghezza tubo	Up to 98.4 ft 3/4" - Up to 82.0 ft 1" Fino a 30 mt 3/4" - Fino a 25 mt 1"
Working pressure Pressione lavoro	Up to 1500 psi / Fino a 100 bar
Working Temperature Temperatura lavoro	212°F - 100°C *
Inlet thread size Connessione Ingresso	1" M
Outlet thread size Connessione uscita	3/4" F
Weight Peso	40 kg
Packing size Dimensione imballo	550x570x630 mm
Raw material sides and roll Materiali costruttivi rullo e fiancate	Carbon Steel Acciaio al carbonio
Raw material shaft and swivel joint Materiali costruttivi perno e giunto	Carbon Steel Acciaio al carbonio
Raw material main spring Materiale molla principale	Carbon Steel Acciaio al carbonio
Can be used to transfer Adatto all'utilizzo con	Air Water / Aria Acqua On request Oil Grease Su richiesta Olio Grasso
Included Accessories Accessori inclusi	Hose bumper (3/4" o 1") Tampone finecorsa (3/4" o 1")

AV5000 CA

Admitted diameters Diametri ammessi	3/4" - 1"
Hose lenght in meters Lunghezza tubo	Up to 98.4 ft 3/4" - Up to 82.0 ft 1" Fino a 30 mt 3/4" - Fino a 25 mt 1"
Working pressure Pressione lavoro	Up to 1500 psi / Fino a 100 bar
Working Temperature Temperatura lavoro	212°F - 100°C *
Inlet thread size Connessione Ingresso	1" M
Outlet thread size Connessione uscita	3/4" F
Weight Peso	40 kg
Packing size Dimensione imballo	550x570x630 mm
Raw material sides and roll Materiali costruttivi rullo e fiancate	Carbon Steel Acciaio al carbonio
Raw material shaft and swivel joint Materiali costruttivi perno e giunto	Carbon Steel Acciaio al carbonio
Raw material main spring Materiale molla principale	Carbon Steel Acciaio al carbonio
Can be used to transfer Adatto all'utilizzo con	Air Water / Aria Acqua On request Oil Grease Su richiesta Olio Grasso
Included Accessories Accessori inclusi	Hose bumper (3/4" o 1") Tampone finecorsa (3/4" o 1")

* This product has been designed for continuous use at a water temperature of 100°C-212°F. Not suitable for use with steam. Report appropriate area «Steam».

* Il prodotto è stato progettato per un utilizzo continuo ad una temperatura dell'acqua di 100°C -212°F. Non adatto all'utilizzo con vapore. Consultare apposita area "Vapore".

RAMEX

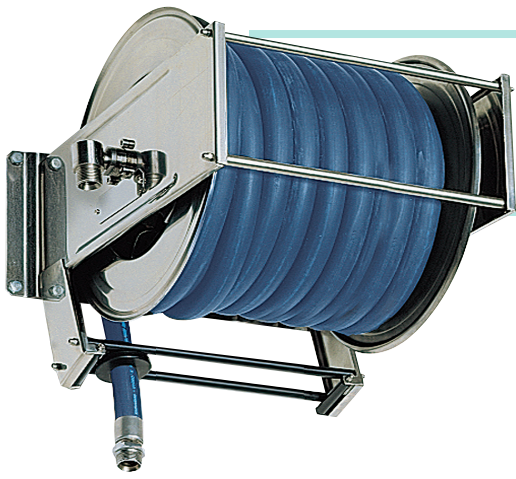

AV5000

EXPLODED VIEW › ESPLOSO

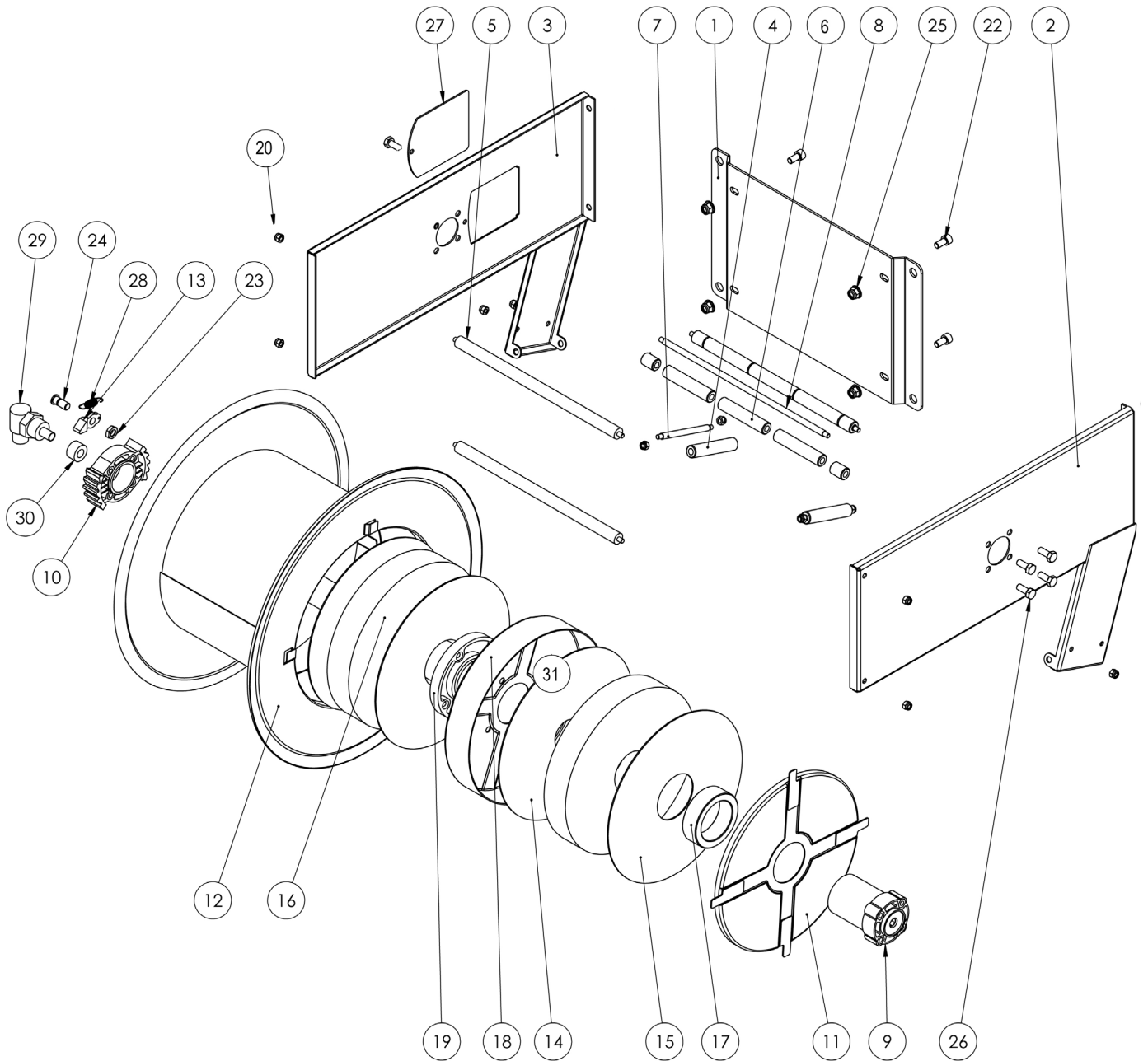

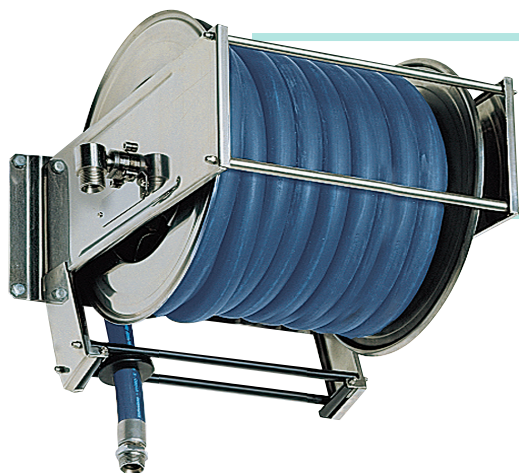

AV5000

EXPLODED VIEW › ESPLOSO

POS	Description and quantity / Descrizione e quantità	AV 5000		AV 5000 316		AV 5000 FE CA	
1	Base (1x)						
2	Side without open / Fiancata senza apertura (1x)						
3	Side with open / Fiancata con apertura (1x)						
4	Vertical roller / Rullino verticale (2x)						
5	Horizontal rod large / Tirante orizzontale grande (2x)						
6	Horizontal roller / Rullino orizzontale (2x)						
7	Vertical rod / Tirante verticale (2x)						
8	Horizontal rod small / Tirante orizzontale piccolo (2x)						
10	Plastic rack / Cremagliera in plastica (1x)	KIT CR 1		KIT CR 1		KIT CR 1	
9	Plastic hub external / Perno in plastica esterno (1x)	KIT 96		KIT 96 316		KIT 96	
11	Spring cover / Copertura molla (1x)						
14	Plastic separator / Distanziale in plastica (2x)						
15	Plastic separator / Distanziale in plastica (2x)						
16	Main spring / Molla principale (2x)						
17	Plastic ring / Anello in plastica (1x)						
18	Spring support / Copertura per supporto (1x)						
19	Plastic internal hub / Perno in plastica interno (1x)	KIT 93		KIT 93 316		KIT 93	
31	Screw for internal hub / Vite per perno interno (4x)						
12	Reel / Bobina (1x)						
20	Nut M6 / Dado M6 (12x)						
22	Screw M8 / Vite M8 (4x)						
25	Nut M8 / Dado M8 (4x)						
26	Screw M8 / Vite M8 (8x)						
27	Plastic closing + screw / Chiusura in plastica + vite (1x)						
13	Plastic ratchet / Salterello in plastica nudo (1x)	KIT 93		KIT 93 316		KIT 93	
23	Nut for ratchet screw / Nut for ratchet screw (1x)						
24	Screw for ratchet / Vite per salterello (1x)						
28	Ratchet spring / Molla per salterello (1x)			KIT 12 316		KIT 12	
29	Swivel joint / Giunto girevole (1x)	4971		4960 1"		4969	
30	Bushing seal / Bushing seal (1x)	KIT20 NEW		KIT20 NEW 316		KIT20 NBR	

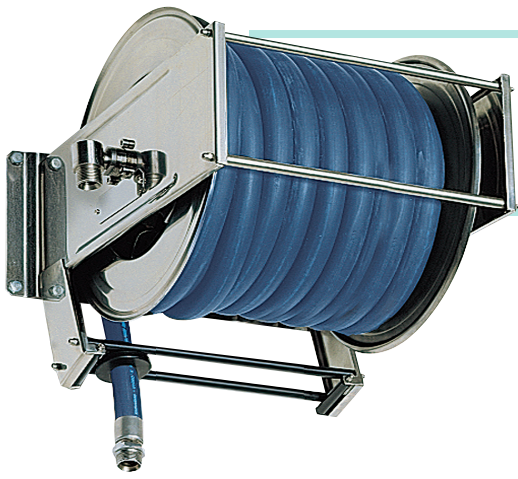

AV5000

DIMENSIONAL DRAWING › DISEGNO DIMENSIONALE

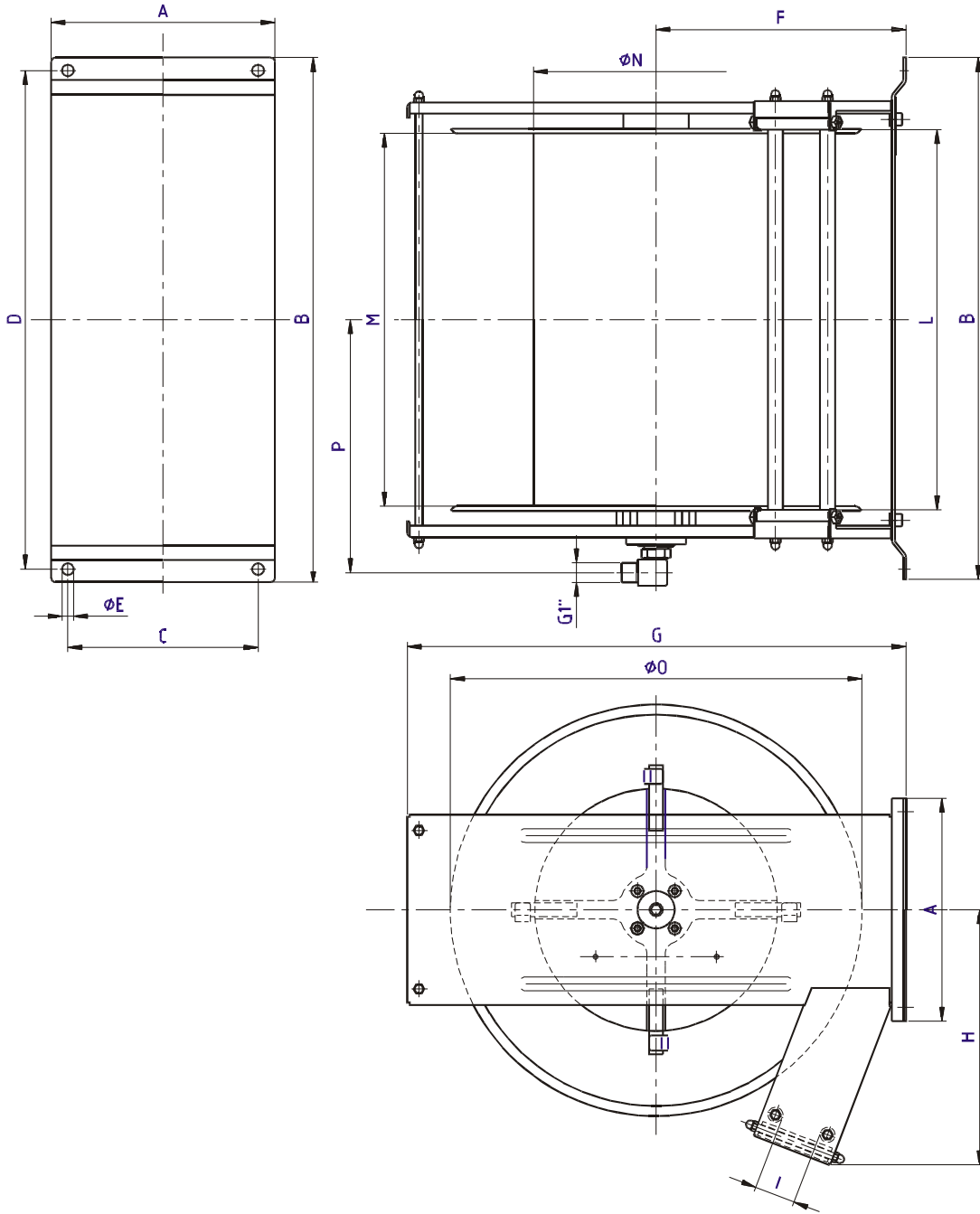

ART.	A	B	C	D	E	F	G	H	I	L	M	N	O	P
AV 5000	290 mm	500 mm	262 mm	470 mm	13 mm	270 mm	533 mm	320 mm	45 mm	360 mm	385 mm	260 mm	430 mm	270 mm









AV5000

INCLUDED ACCESSORIES › ACCESSORI INCLUSI

HOSE REEL AVVOLGITUBO	HOSE BUMPER FERMATUBO		NIPPLE NIPPLO	SWIVEL JOINT GIUNTO GIREVOLE		
AV 5000	4941		4914		4971	
AV 5000 316			4914 - 316		4960 - 1"	
AV 5000 FE			4915		4969	
AV 5000 CA						

OPTIONAL ACCESSORIES › ACCESSORI OPTIONAL

HOSE REEL AVVOLGITUBO	HOSE BUMPER FERMATUBO		NIPPLE NIPPLO	
AV 5000	4940		4916	
AV 5000 316			4916 - 316	
AV 5000 FE			4917	
AV 5000 CA				

HOSE TUBO	STANDARD FITTING RACCORDO STANDARD		OPTION OPZIONE	
43 3/4" 	4923		4927	
45 3/4" 				
61 3/4" 				
43 1" 	4923 1"		4928	
45 1" 				
61 1" 				